



Specification for Lipo Rechargeable Battery

Model: PLS8050110 3.7V 4000mAh

Prepared by	Checked by	Approved by

Customer Name:

Comment:

Customer Approval /Date:

Address: 2nd Floor, No. 4, Hebe Road, Tangxia Town, Dongguan City, Guangdong Province

Tell: +86 13480631900, +86 17704074080

Email: sales@plsbattery.com

Website: www.plsbattery.com



Amendment Records

Revision	Description	Prepared by	Approved by	Date
A	First Publish			2013-1-15



Content

1. Scope	Page 4
2. Model	Page 4
3.Cell Specification	Page 4
4. Battery/Cell performance test Criteria	Page 5
4.1 Appearance inspection by visual	Page 5
4.2 Environmental test condition	Page 5
4.3 Electrical characteristics	Page 5
4.4 Mechanical characteristics	Page 6
4.5 Safety performance	Page 7
5. Cell initial Dimensions	Page 8
6. Battery specification	Page 9
7. PCB specification	Page 10
8. PCB drawing	Page 11
9. PCB BOM List	Page 12
10. battery pack dimension	Page 13
11. Handling of cells	Page 14
12. Notice for designing battery pack	Page 14
13. Notice for assembly battery pack	Page 15
14. Others	Page 15
15. Storage of batteries	Page 16
16. The Chemical reaction	Page 16
17. Note	Page 16



PLS Battery Co., Ltd

Ver: **A0**

DATE: **2013-1-15**

DOC No:PLS8050110-A0

1 Scope

This specification is applying to describe the related Battery product in this Specification and the Battery/cell supplied by PLS Battery Co., Ltd only.

2 Model: **PLS8050110**

3 Cell Specification

No.	Items	Specifications		Remark
1	Nominal Capacity	4000mAh		0.2C Standard discharge 0.2C
2	Minimum Capacity	3950mAh		
3	Nominal Voltage	3.7V		Mean Operation Voltage
4	Delivery voltage	3.7~3.9V		Within 10 days from Factory
5	Charge Voltage	4.2V±0.03V		By standard charge method
6	Standard charging method	0.2C constant current,4.2V constant voltage charge to 4.2V,continue charging till current decline to ≤0.01C		About 6.5h (Ref)
7	Charge current	0.2C	800mA	Standard charge, charge time:6.5h(Ref)
		0.3C	1200mA	Rapid Charge, charge time:4.5h(Ref)
8	Standard discharging method	0.2C constant current discharge to 3.0V,		
9	Cell Internal Impedance	≤40mΩ		Internal resistance measured at AC 1KHz after 50% charge
10	Weight	About 77g		
11	Maximum charge current	0.3C	1200mA	For continuous charging mod
11	Maximum discharge current	1C	4000mA	For continuous discharge mod
13	Operation Temperature and relative humidity Range	Charge	0~45°C 60±25%R.H.	Charge at a very low temperature such as below 0°C,will be get a lower capacity and reduce cycle life of the battery
		Discharge	-10~60°C 60±25%R.H.	
14	Storage temperature for a long time	-20~25°C 60±25%R.H.		Do not storage exceed half year. Must charge once when storage for half year. Must charge the battery which with protect circuit when storage for three mouths.



4. Battery/Cell performance test Criteria

4.1 Appearance inspection by visual

There shall be no such defect as flaw, crack, rust, leakage, which may adversely affect commercial value of battery.

4.2 Environmental test condition

Unless otherwise specified, all test stated in this product specification are conduct at below test condition

Temperature: 20°C~25°C

Relative Humidity:60%±25% R.H.

4.3 Cell Electrical characteristics

No	Items	Test Method and Condition	Criteria	
1	Rated Capacity at 0.2C(Min.)	After standard charge,the capacity shall be measured on 0.2C discharge till the voltage discharge to 3.0V,	≥4000mAh	≥100%
	Rated Capacity at 0.5C(Min.)	After standard charge,the capacity shall be measured on 0.5C discharge till the voltage discharge to 3.0V	≥98%	
	Rated Capacity at 1C(Min.)	After standard charge,the capacity shall be measured on 1C discharge till the voltage discharge to 3.0V,	≥95%	
2	Cycle Life	Charging and discharging battery as blew conditions 0.2C standard charge to 4.2V end-off 0.2C standard discharge to 3.0V cut-off Continuous charge and discharge for 500 cycles,the capacity will be measure after the 500 th cycle	≥70% of initial capacity	
3	Capacity retention	The battery to be charge in accordance with standard charge condition at 20~25°C,then storage the battery at an ambient temperature 20~25°C for 28 days. Measure the capacity after 30 days with 0.2C at 20~25°C as retention capacity	Retention capacity ≥85%	



4.4 Mechanical characteristics

No	Items	Test Method and Condition	Criteria
1	Free fall test	The battery to be fully charged in accordance with standard charge condition, then drop the battery three times from a height of 1,0 m onto a concrete floor. The batteries are dropped so as to obtain impacts in random orientations.	No Fire,
2	Vibration test	After standard charging, fixed the cell to vibration table and subjected to vibration cycling that the frequency is to be varied at the rate of 1Hz per minute between 10Hz and 55Hz, the excursion of the vibration is 1.6mm. The cell shall be vibrated for 30 minutes per axis of XYZ axes.	No explosion, No leakage, No fire
3	Crush test	Fully charged the battery in accordance with standard charge condition, the battery is to be crushed between two flat plates. Continuous to applied force on battery of 13kN(17.2Mpa),stopped until a pressure reading of 17.2Mpa is reached on the hydraulic ram	No explosion, No fire
4	Shock test	The fully charged battery is secured to the testing machine by means of a rigidmount which will support all mounting surfaces of the cell or battery. The battery is subjected to a total of three shocks of equal magnitude. The shocks are applied in each of three mutually perpendicular directions. At least one of them shall be perpendicular to a flat face. For each shock the cell or battery is accelerated in such a manner that during the initial 3 milliseconds the minimum average acceleration is 75 gn. The peak acceleration shall be between 125 gn and 175 gn. Cells or batteries are tested in an ambient temperature of 20~25°C	No explosion, No leakage, No fire



4.5 Safety performance

No	Items	Test Method and Condition	Criteria
1	Thermal exposure test	Each fully charged cell, stabilized at room temperature, is placed in a circulating air-convection oven. The oven temperature is raised at a rate of 5 °C/min ± 2 °C/min to a temperature of 130 °C ± 2 °C. The cell remains at this temperature for 10 min before the test is discontinued.	No explosion, No fire
2	Low pressure	Each fully charged cell is placed in a vacuum chamber, in an ambient temperature of 20~25°C. Once the chamber has been sealed, its internal pressure is gradually reduced to a pressure equal to or less than 11,6 kPa (this simulates an altitude of 15240 m) held at that value for 6 h.	No explosion, No leakage, No fire
3.	Short test	The fully charged battery is to be short-circuited by connecting the positive and negative terminals of the battery with resistance load not exceed 100m Ω. Tests are to be conducted at room temperature 20~25°C.	No explosion, No fire The Temperature of the Battery surface not exceeded than 150°C
4	Forced discharge test	A discharged cell is subjected to a reverse charge at 1C for 90 min.	No explosion, No fire
5	Over charge test	After standard charge, continue to charge with a constant voltage 4.6V per a cell, holding 8h.	No explosion, No fire, No leakage
6	Soak Test	Put the batteries into clean water, be soaked for 24 hours.	No break, No fire



5. Cell initial Dimensions

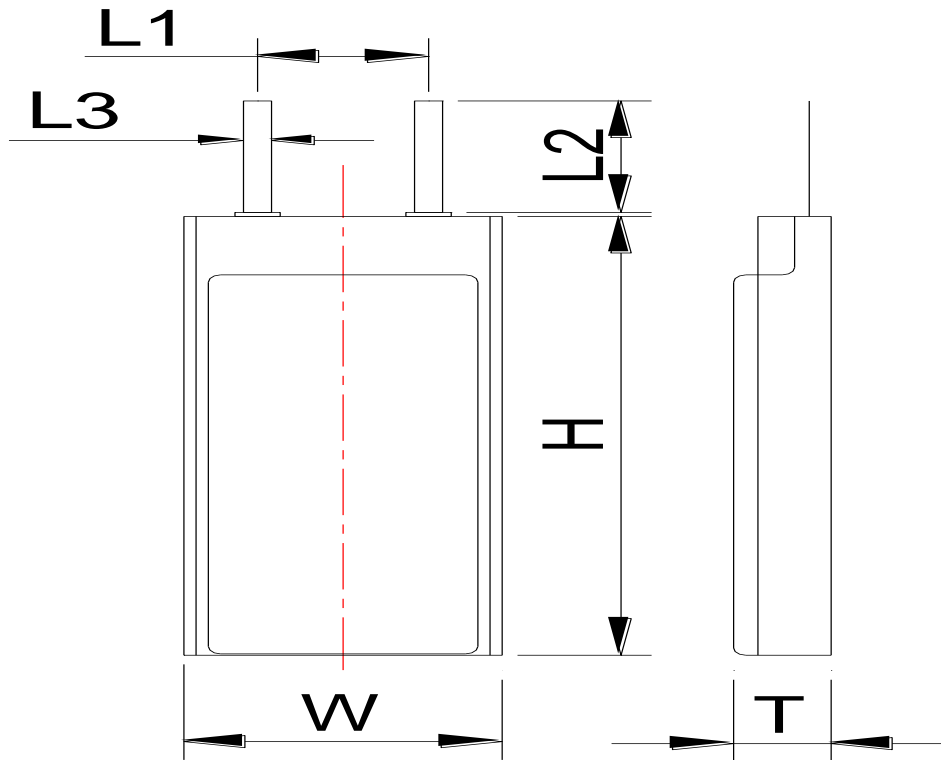

NO	Items	Units:mm	Remark
1	Thickness	8.2	Max.
2	Width	50	Max.
3	Height	111	Max.
4	L1		
5	L2		
6	L3		



6. Battery specifications

No.	Items	Specifications	Remark
1	Capacity for assembled cell discharging by 0.2C	$\geq 4000\text{mAh}$	Standard discharging method
2	Battery Voltage	3.7V~3.9V	Delivery voltage, within 10 days from Factory
3	Standard charge condition	Charge with 0.2C constant current and 4.2V constant voltage, charge to 4.2V, continue charging till current decline to $\leq 0.01\text{C}$	Charge voltage: $4.2\text{V} \pm 0.02\text{V}$ Charge current: 0.2C
4	Standard discharging method	0.2C constant current discharge to 3.0V,	
5	Internal Impedance	Assemblage Impedance $\leq 40\text{m}\Omega$	Measure two sides of the drawing line after assembling.



7. PCM specification

Item	Symbol	Content	Criterion
Over charge Protection	V_{DET1}	Over charge detection voltage	$4.275 \pm 0.02V$
	tV_{DET1}	Over charge detection delay time	$1.0 \pm 0.2S$
	V_{REL1}	Over charge release voltage	$4.175 \pm 0.025V$
		Maximum charge current	$\leq 4.0A$
Over discharge protection	V_{DET2}	Over discharge detection voltage	$3.0 \pm 0.035V$
	tV_{DET2}	Over discharge detection delay time	$125 \pm 25mS$
	V_{REL2}	Over discharge release voltage	$3.2 \pm 0.1V$
Over current protection	V_{DET3}	Over current detection voltage	$0.125 \pm 0.015V$
	I_{DP}	Over current detection current	7-10A
	tV_{DET3}	Detection delay time	$12 \pm 2.4mS$
		Release condition	Cut load
		Maximum continuous current	$\leq 8A$
Short protection		Detection condition	Exterior short circuit
	T_{SHORT}	Detection delay time	$280 \sim 560\mu S$
		Release condition	Cut short circuit
Interior resistance	R_{SS}	Main loop electrify resistance	$V_c=3.7V; R_{SS} \leq 70m\Omega$
Current consumption	I_{DD}	Current consume in normal operation	6.0 μA Max



Ver:	A0
DATE:	2013-1-15
DOC No:PLS8050110-A0	

8 8.1Application Circuit

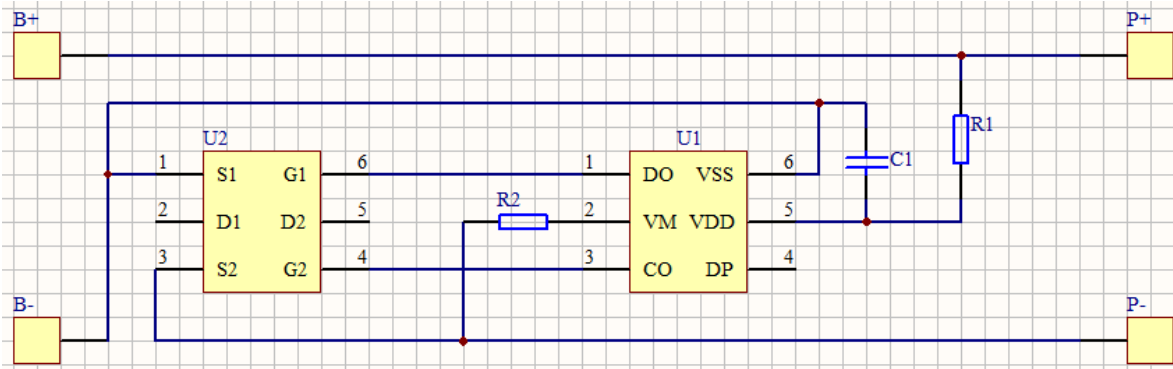

8.2 PCB layout

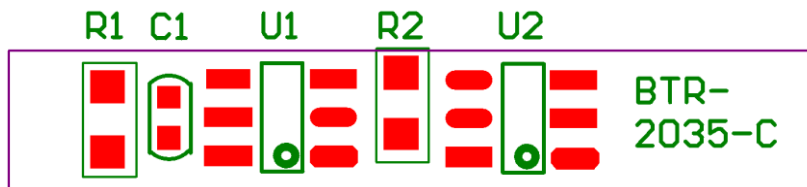
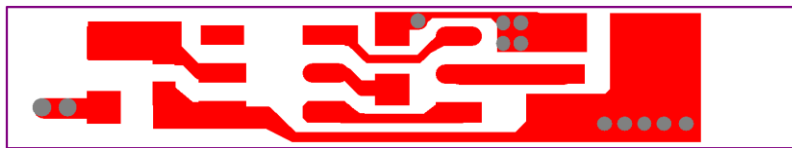



PLS Battery Co., Ltd

Ver: A0

DATE: 2013-1-15

DOC No:PLS8050110-A0

9. PCM BOM LIST

No.	description	vendor	symbol	Spec./model	unit	Q' ry
1	PCB			BTR-2035-C	pcs	1
2	Res		R1	470/0603	pcs	1
3	Res		R2	2K/202	pcs	1
4	Cap		C1	0.1uF (104) 16V	pcs	1
5	IC		T1	G3J	pcs	1
7	MOS		T2	8205S/TSSOP-8	pcs	1



10. Battery Pack Dimensions

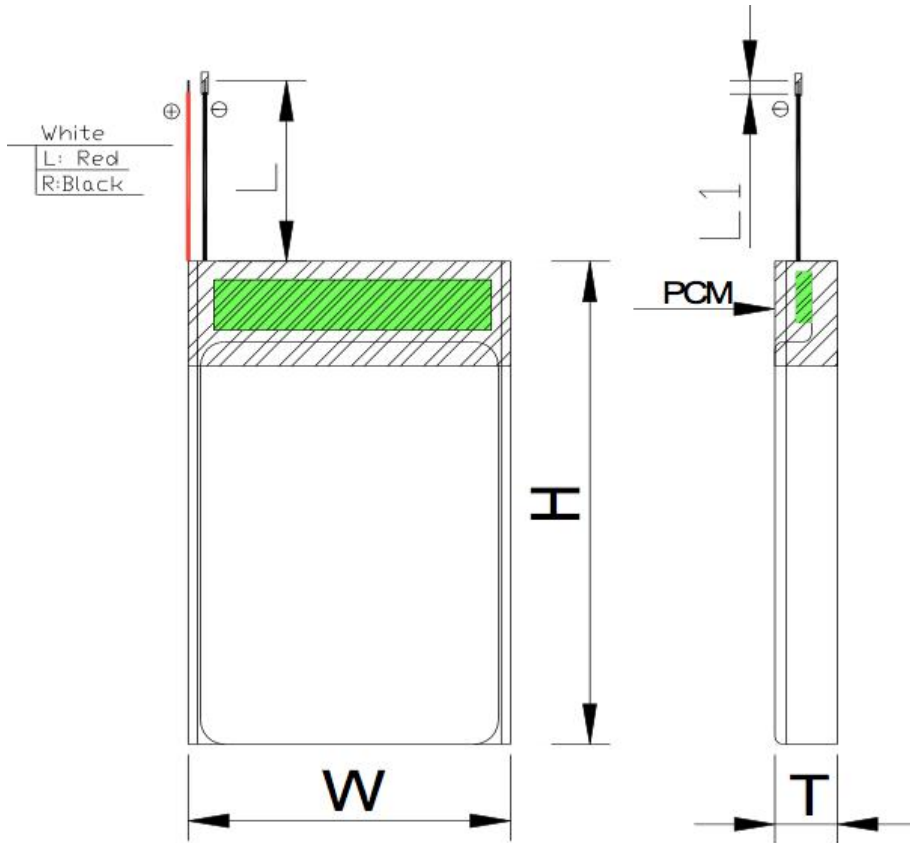

NO	Items	Units: mm		Remark
1	Thickness	T	8.2	Max.
2	Width	W	50	Max.
3	Height	H	111.5	Max.
4	Cable Length	L	optional	
5	Peel off	L1	2-3mm	

BOM of Battery Pack

NO	Part name	Quantity	Unit	Remark
1	Cell	1	ea	
2	Tape	~440~	mm	
3	Solder	0.2	g	Lead Free
4	Lead	2	Ea	1571#30
5	PCM	1	pcs	



11. Handling of Cells

1. 11.1 Consideration of strength of film package
 - 1) Soft Aluminium foil
Easily damaged by sharp edge parts such as pins and needles, Ni-tabs, so don't strike by those sharp parts.
 - 2) Sealed edge may be damaged by heat above 100 °C, bend or fold sealed edge.
2. 11.2 Prohibition short circuit
Never make short circuit cell. It generates very high current which causes heating of the cells and may cause electrolyte leakage, gassing or explosion, that are very dangerous.
The LIP tabs may be easily short-circuited by putting them on conductive surface.
Such outer short circuit may lead to heat generation and damage of the cell.
An appropriate circuitry with PCM shall be employed to protect accidental short circuit of the battery pack.
11.3.Mechanical shock
LIP cells have less mechanical endurance than metal-can-cased LIB.
Falling, hitting, bending, etc. may cause degradation of LIP characteristics.
11.4 Handling of tabs
The battery tabs are not so stubborn especially for aluminium tab.
Don't bend tab.
Do not bend tabs unnecessarily.

12. Notice for Designing Battery Pack

- 12.1 Pack toughness
Battery pack should have sufficient strength and the LIP cell inside should be protected from mechanical shocks.
- 12.2 Cell fixing
The LIP cell should be fixed to the battery pack by its large surface area.
No cell movement in the battery pack should be allowed.
- 12.3 Inside design
No sharp edge components should be inside the pack containing the LIP cell.
- 12.4 Tab connection
Ultrasonic welding or spot welding is recommended for LIP tab connection method.
Battery pack should be designed that shear force are not applied to the LIP tabs.
If apply manual solder method to connect tab with PCM, below notice is very important to ensure battery performance:
 - 1) The solder iron should be temperature controlled and ESD safe;
 - 2) Soldering temperature should not exceed 350 °C;
 - 3) Soldering time should not be longer than 3s;



4) Soldering times should not exceed 5 times, keep battery tab cold down before next time soldering;

5) Directly heat cell body is strictly prohibited, Battery may be damaged by heat above approx. 100 °C

12.5 For mishaps

Battery pack should be designed not to generate heat even when leakage occurs due to mishaps.

- 1) Isolate PCM (Protection Circuit Module) from leaked electrolyte as perfectly as possible.
- 2) Avoid narrow spacing between bare circuit patterns with different voltage.

(Including around connector)

LIP battery should not have liquid from electrolyte, but in case If leaked electrolyte touch bare circuit patterns, higher potential terminal material may dissolve and precipitate at the lower potential terminal, and may cause short circuit. The design of the PCM must have this covered.

13. Notice for Assembling Battery Pack

Shocks, high temperature, or contacts of sharp edge components should not be allowed in battery pack assembling process.

14. Others

14.1 Cell connection

- 1) Direct soldering of wire leads or devices to the cell is strictly prohibited.
- 2) Lead tabs with pre-soldered wiring shall be spot welded to the cells.

Direct soldering may cause damage of components, such as separator and insulator, by heat generation.

14.2 Prevention of short circuit within a battery pack

Enough insulation layers between wiring and the cells shall be used to maintain extra safety protection. The battery pack shall be structured with no short circuit within the battery pack, which may cause generation of smoke or firing.

14.3 Prohibition of disassembly

- 1) Never disassemble the cells

The disassembling may generate internal short circuit in the cell, which may cause gassing, firing, explosion, or other problems.

- 2) Electrolyte is harmful

LIP battery should not have liquid from electrolyte flowing, but in case the electrolyte come into contact with the skin, or eyes, physicians shall flush the electrolyte immediately with fresh water and medical advice is to be sought.



14.4 Prohibition of dumping of cells into fire

Never incinerate nor dispose the cells in fire. These may cause explosion of the cells, which is very dangerous and is prohibited.

14.5 Prohibition of cells immersion into liquid such as water

The cells shall never be soaked with liquids such as water, seawater, drinks such as soft drinks, juices, coffee or others.

14.6 Battery cells replacement

The battery replacement shall be done only by either cells supplier or device supplier and never be done by the user.

14.7 Prohibition of use of damaged cells

The cells might be damaged during shipping by shock. If any abnormal features of the cells are found such as damages in a plastic envelop of the cell, deformation of the cell package, smelling of an electrolyte, an electrolyte leakage and others, the cells shall never be used any more.

The Cells with a smell of the electrolyte or a leakage shall be placed away from fire to avoid firing or explosion.

15. Storage of the Batteries

The batteries should be stored at room temperature, charged to about 30% to 50% of capacity.

We recommend that batteries be charged about once per half a year to prevent over discharge.

16. Other The Chemical Reaction

Because batteries utilize a chemical reaction, battery performance will deteriorate over time even if stored for a long period of time without being used. In addition, if the various usage conditions such as charge, discharge, ambient temperature, etc. are not maintained within the specified ranges the life expectancy of the battery may be shortened or the device in which the battery is used may be damaged by electrolyte leakage. If the batteries cannot maintain a charge for long periods of time, even when they are charged correctly, this may indicate it is time to change the battery.

17. Note

Any other items which are not covered in this specification shall be agreed by both parties.